

# Distributed Fiber-Optic Sensors Based on Principle of Stimulated Brillouin Scattering

Igor Bogachkov<sup>1</sup>, Nikolai Gorlov<sup>2</sup> and Evgenia Kitova<sup>3</sup>

<sup>1</sup>*Department of Communications and Information Security, Mira Str. 11, Omsk State Technical University, 644050 Omsk, Russian Federation*

<sup>2</sup>*Department of Communication Lines, Siberian State University of Telecommunications and Computer Science, Kirov Str. 86, 630102 Novosibirsk, Russian Federation*

<sup>3</sup>*Department of Foreign Languages, Novosibirsk State Technical University, Karl Marx avenue 20, 630073 Novosibirsk, Russian Federation*

*bogachkov@mail.ru, gorlovnik@yandex.ru, kitovaet@mail.ru*

**Keywords:** Optical Fiber, Brillouin Scattering, Distributed Temperature Sensors, Optical Fiber Sensors.

**Abstract:** The report is devoted to the analysis of distributed fiber-optic sensors based on the phenomenon of stimulated Brillouin scattering. They are of great interest for research due to their ability to measure the temperature and strains at superlong distances with high accuracy and high spatial resolution. The functional dependences of the output signals characteristics on parameters measured by the sensors are given in the paper. Of particular interest are the results of the analysis of the spectral component shifts in the Brillouin light scattering depending on the fiber elongation and temperature. After a brief review of the basic theoretical principles the results of some researches aimed to expand the dynamic range and to increase spatial resolution. The results of simulation in professional design software environment OptiSystem 17.1 are described in the article. To test the simulation results and detection of common features in spectrograms the experimental testing was carried out. The results obtained show that it is possible to implement fiber-optic sensors based on Brillouin scattering in telecommunication systems, mining, oil and gas industry, as well as in electric-power industry, construction, aviation and space industry. The objectives for the further research are to perform metrological analysis at all stages of the method implementation, to complete the base of Brillouin spectrograms for optical fiber of various types and to improve algorithms for automated processing spectra in order to expand functionality of the systems. In conclusion, the overview of some applications is given in this paper.

## 1 INTRODUCTION

Optic fibers are widely used as communication channels in which light waves can be transmitted over long distances. In this situation fiber lines are isolated from external disturbances by means of cable technologies. However, by increasing environmental influences on the properties of light penetrating into the waveguide, fiber can be used for detection, monitoring and even measurement of external disturbances (measured values) in the integrated or distributed format. When optical power exceeds the prescribed power threshold, nonlinear phenomena, such as Brillouin scattering due to its strong dependence on external environmental variables (deformation and temperature), then the

waveguide can be used successfully in optic sensor systems. In these cases, the optic fiber is a medium in which interaction occurs, acting simultaneously as both a distributed converter and an optical channel. These sensors can measure changes in particular parameter along the whole fiber converter. Therefore, dynamic range, correlated to the maximum fiber length and spatial resolution of the converter (minimal fiber length required for measurement during serial disturbances or events) are key factors which are significant and they should be investigated [1].

Fiber-optic sensors have the following advantages compared to their traditional counterparts [2]:

- fiber-optic line is explosion- and fireproof;

- optic fiber has high resistance to the influence of corrosive media, pressures and temperatures;
- optical signal in the fiber sensor is not affected by electric or magnetic interference caused by the operation of other technical systems;
- fiber sensors are distributed data collection system with the remote information processing devices;
- they easily operate in combination with optical information processing systems;
- small size and weight of optic fiber;
- high corrosion resistance, especially to chemical solvents, oil and water;
- free of induction;
- low cost.

The above advantages make it possible to design, manufacture and technical operation of distributed systems for monitoring of long lines along the whole length in real-time (overhead and underground communication lines, electric power lines, bridges, dams), where it is necessary to control the strength of the structure and the risk of an emergency. In addition, these systems successfully solve the problem of measuring the temperature along the entire well drilling for a long period.

## 2 THEORETICAL BACKGROUND

A distributed fiber-optic sensor is a kind of measuring instrument. It transforms a physical quantity which is measured into the optical signal. This signal is transmitted through the optical fiber to a processing device to process the optical signals. Algorithms used for processing the intermediate data received are provided by the required metrological sensor characteristics. Furthermore, they provide the information presentation in tabular or graphical format.

The measurement principles used in the proposed fiber-optic sensor are based on the Mandelstam-Brillouin scattering (scattering by acoustic phonons) in the optical fiber. Brillouin scattering results in the formation of the backward wave in the fiber. By scanning the carrying frequency of this wave, you can determine the distribution of the Brillouin scattering spectrum along the fiber and, consequently, the maximum signal frequency in this spectrum, Figure 1 [3].

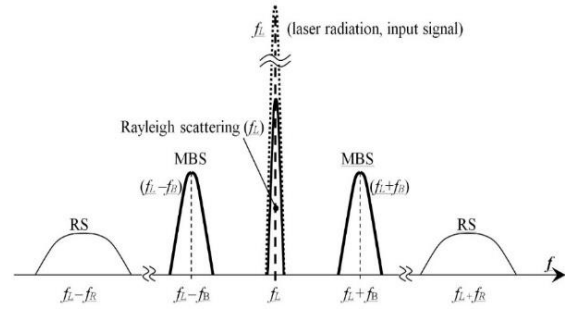

Figure 1: Spectrum of light scatterings in the fiber ( $f_B \sim 10 \dots 11$  GHz,  $f_R \sim 13$  THz).

The system of the distributed sensing, which is based on the Brillouin scattering can simultaneously measure temperature and strain along the fiber. Typically, the intensity of light and the frequency shift in the Brillouin scattering is affected by the temperature and deformation in the fiber. These are defined by the following (1) [4]:

$$\begin{bmatrix} \Delta v_B(T, \varepsilon) \\ \Delta P_B(T, \varepsilon) \end{bmatrix} = \begin{bmatrix} C_{v,T} & C_{v,\varepsilon} \\ C_{p,T} & C_{p,\varepsilon} \end{bmatrix} \begin{bmatrix} \Delta T \\ \Delta \varepsilon \end{bmatrix}, \quad (1)$$

where:

$\Delta P_B(T, \varepsilon)$  – variations of power in the Brillouin scattering spectrum;

$\Delta v_B(T, \varepsilon)$  – shift of the central frequency in the Brillouin scattering;

$\Delta T$  – fluctuations in fiber temperature;

$\Delta \varepsilon$  – fluctuations in fiber strain;

$C_{p,T}$  and  $C_{p,\varepsilon}$  are temperature coefficients and the strain coefficient for the Brillouin scattering power respectively;

$C_{v,T}$  and  $C_{v,\varepsilon}$  are also the coefficients of temperature and strain for the shift of the Brillouin frequency depending on temperature and strain.

These preset values of the coefficients are given in Table 1:

Table 1: The relationship of Brillouin light scattering intensity and frequency shift and temperature coefficient.

	Strain coefficient	Temperature coefficient
Brillouin scattering optical power variation $\Delta P_B$	$C_{p,\varepsilon} = -8 \pm 1 \times 10^{-4} \%/ \mu \varepsilon$	$C_{p,T} = +0.33 \pm 0.3 \%/ K$
Brillouin scattering optical frequency shift $\Delta v_B$	$C_{v,\varepsilon} = -0.052 \pm 0.004 \text{ MHz}/\mu \varepsilon$	$C_{v,T} = +1.09 \pm 0.083 \text{ MHz}/ K$

Linear coefficient for temperature and strain can be accurately determined from the inverse matrix in (1) and can be written as [5]:

$$\Delta T = \frac{|C_{P,\varepsilon} \cdot \Delta \nu_B + |C_{v,\varepsilon}| \cdot \Delta P_B}{|C_{P,T} C_{v,\varepsilon} - C_{P,\varepsilon} C_{v,T}|} \quad (2)$$

$$\Delta \varepsilon = \frac{|C_{P,T} \cdot \Delta \nu_B + |C_{v,T}| \cdot \Delta P_B}{|C_{P,T} C_{v,\varepsilon} - C_{P,\varepsilon} C_{v,T}|} \quad (3)$$

By measuring the power of the scattered signal and the shift of the Brillouin frequency, it is possible to obtain the temperature and strain distribution along the fiber.

Distributed Brillouin fiber-optic sensors provide innovative solutions to control the temperature and strain in distributed constructions. The effective range for these sensors is about 20-30 km, which is limitation for their use in some applications where the distance is much longer. In order to increase the operating range, the methods are proposed in paper [6], based on distributed Raman amplification. Three Raman pumping configurations were investigated theoretically and experimentally: joint propagation, counter propagation and bidirectional propagation with respect to the Brillouin pump pulse. The study shows that some of the amplification schemes tested can significantly extend the measurement range and improve the quality of measurements over large distances.

The paper [7] proposes a combined amplification of the second order and optical pulse coding to expand the real dynamic range for distributed fiber-optic sensor. The analysis presented and the experimental results show that the appropriate optimization of these two methods makes it possible to enhance the signal/noise ratio measurements when using a superlong and sensitive fiber. This solution increases the sensing distance to 120 km with a spatial resolution of 5 m.

In order to increase the spatial resolution, the paper [8] proposes and shows a new differential method of optical reflectometry. By analyzing spatiotemporal property of the pulse excited by Brillouin spontaneous light scattering, it made it possible to obtain the distribution of the Brillouin weighting coefficient along the fiber. Based on this distribution a method of two-step subtraction is offered. A pair of pulses with a small difference in width is used as a probe pulse. When performing the two-stage subtraction on these two pairs of Brillouin spectrum it is proved theoretically and experimentally that the differential Brillouin spectrum is spatially associated with the difference in width of pulse pair. The spatial resolution of 0.4

m is obtained experimentally when using pulse pairs 60/56 ns for the probing length of 7.8 km with accuracy of the Brillouin frequency of 4.1 MHz.

The analysis results of the noise by using Monte-Carlo method to correct the dependences between the frequency resolution, quality, signal/noise ratio and the frequency step in the distributed Brillouin fiber-optic sensors are presented in [9]. Quantitative estimation of the Brillouin amplification spectrum is of great importance for the distributed sensors to increase the Brillouin frequency resolution and corresponding Brillouin tension and temperature resolutions. To estimate the error in determination of the Brillouin central frequency spectrum two analytical expressions were obtained with polynomial second order fitting and without it.

In paper [10], an equivalent Rayleigh criterion is offered to measure stressed cross section and smaller spatial resolution for the Brillouin distributed sensor. According to this criterion, at any preset probing length the minimum allowable tension length is 1/2 of the pulse length at Brillouin frequency uncertainty of 5%.

### 3 RESULTS AND DISCUSSION

The simulation was carried out in the professional design environment OptiSystem 17.1. It is a comprehensive program software Design Suite, which allows users to plan, test and simulate processes in optical fibers in current telecommunication systems. The computer simulation scheme is shown in Figure 2.

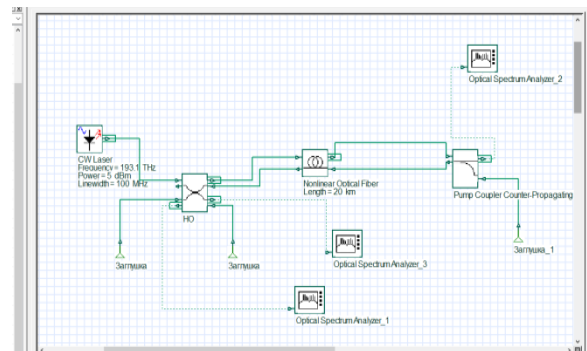

Figure 2: Simulation scheme.

The following component parameters were set in Figures 3-4.

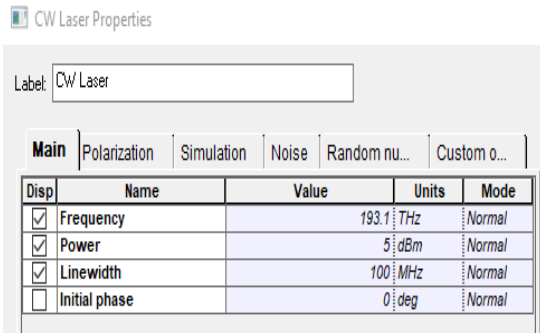

Figure 3: Laser parameters.

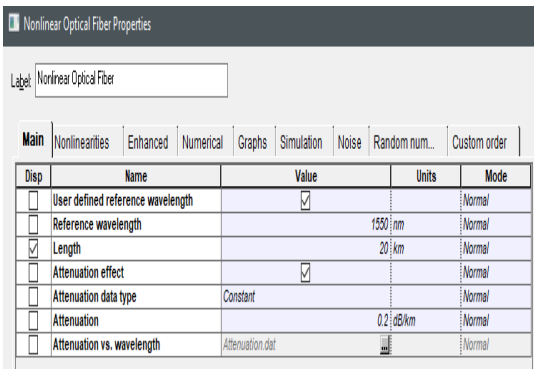

Figure 4: Optical fiber parameters.

The simulation results are shown in Figures 5-7.

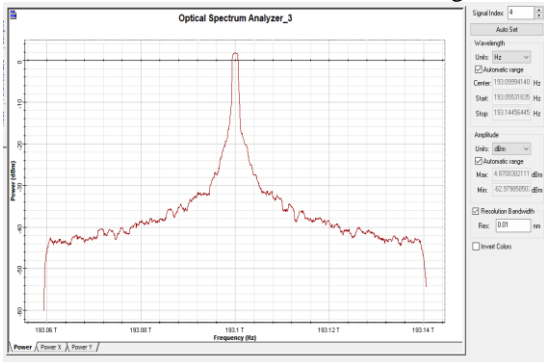

Figure 5: The signal at the output of optical fiber (Port no. 4 of the directional coupler).

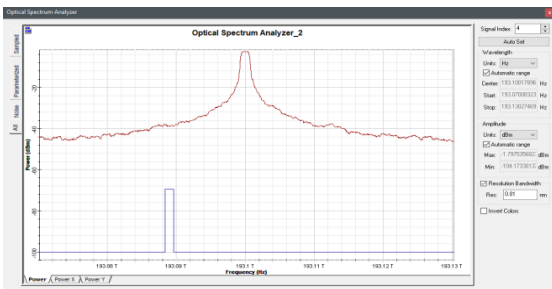

Figure 6: Signal at the output of the optical fiber.

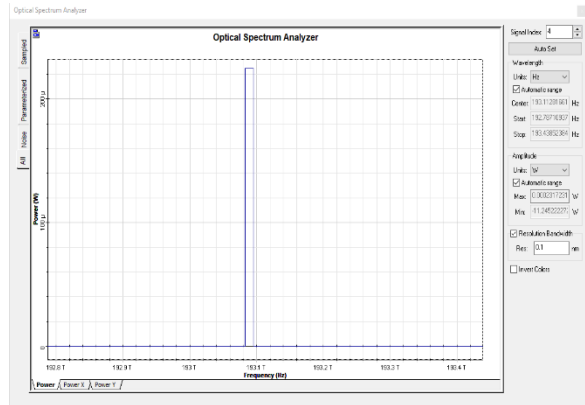

Figure 7: Spectrum of the backscattered component.

In order to test the simulation results and identify common patterns in spectrograms the experimental studies were conducted by using Brillouin optical reflectometer manufactured by the company “Ando” “AQ 8603”. For experimental studies, a one-mode optical fiber of the standard G.652 was chosen. Figures 8 and 9 show the spectrograms for the same fiber, in which a section was heated or longitudinally stretched.

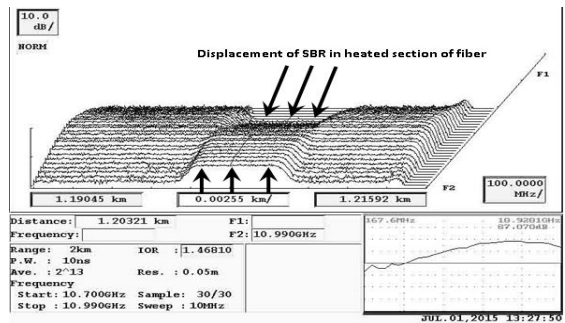

Figure 8: Spectrogram of the optical fiber section heated to 100°C.

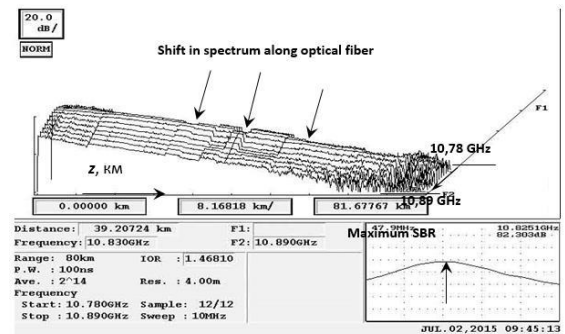

Figure 9: 3D spectrogram along OF in fiber-optic cable more than 70 km.

After spectrogram processing the picture of strain distribution in optical fiber along longitudinal coordinate is obtained. It is shown in Figure 10.

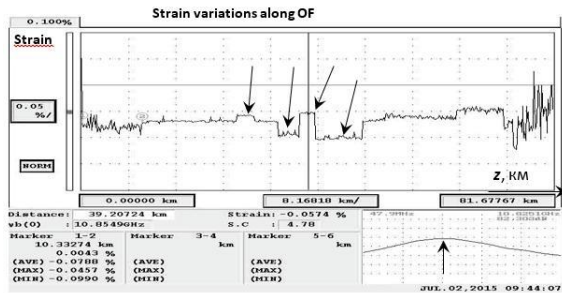

Figure 10: Strain profile in optical fiber.

Figures 8 – 10 show that changes in temperature and tension lead to a frequency shift, which makes it possible to detect areas with changes in these characteristics along the light-guide (distributed optical sensor). Each cross section in 3D-reflectogram along distance axis is a fiber reflectogram for fixed frequency. Each section along frequency axis is a profile of Brillouin spectrum in this section. In the right bottom the maximum shift of Brillouin scattering spectrum is shown. The shift equals 10.78 GHz and correlates to simulation result.

Differences in the impact factors (longitudinal tension or temperature change) in the fiber can be detected by the analysis of the back-reflected signal intensity of the Brillouin scattering ((1), Table 1). Under the stretching condition, the back-reflected signal intensity decreases. As the temperature rises, this intensity increases.

## 4 CONCLUSIONS

Fiber-optic sensors based on the principle of Brillouin scattering can be widely used in mining, oil and gas industries as well as in power industry, construction, aviation and space industries. They have already taken significant place in telecommunication systems for early diagnostics of damages in fiber-optic communication lines. The objectives of further research are to perform metrological analysis at all stages of the method implementation, to complete the base of Brillouin spectrograms for optical fiber of various types and to improve algorithms for automated processing spectra. The presented simulation results demonstrate the possibilities for analyzing distributed optical sensors in “OptiSystem” software.

The results obtained give evidence that Brillouin scattering spectrum analysis makes it possible to measure tension and temperature along longitudinal coordinate in optical fiber. In this process the optical fiber is both sensor and transmission media. This is the main advantage of optic-fiber sensors compared to other optic fiber sensors operating with other physical phenomena.

## REFERENCES

- [1] R. Bernini, A. Minardo, and L. Zeni, “Self-demodulated heterodyne frequency domain distributed Brillouin fiber sensor,” *IEEE Photonics Technology Letters*, vol. 19, pp. 447-449, March 2007.
- [2] Y. Li, X. Bao, Y. Dong, and L. Chen, “A novel distributed Brillouin sensor based on optical differential parametric amplification”, *Journal of Lightwave Technology*, vol. 28, pp. 2621-2626, September 2010.
- [3] J. Urricelqui, F. Fernandez, M. Sagues, and A. Loayssa, “Polarization diversity scheme for BOTDA sensors based on a double orthogonal pump interaction”, *Journal of Lightwave Technology*, vol. 33, pp. 2633-2637, June 2015.
- [4] M. Belal and T. P. Newson, “Experimental examination of the variation of the spontaneous Brillouin power and frequency coefficients under the combined influence of temperature and strain”, *Journal of Lightwave Technology*, vol. 30, pp.1250-1255, May 2013.
- [5] J. Luo, Y. Hao, Q.Ye, and L. Li, “Development of optical fiber sensors based on Brillouin scattering and FBG for on-line monitoring in overhead transmission lines”, *Journal of Lightwave Technology*, vol. 31, pp.1559-1565, May 2013.
- [6] F. Barrios, S. López, A. Sanz, P. Corredera, and J.Castañón, “Distributed Brillouin fiber sensor assisted by first-order Raman amplification”, *Journal of Lightwave Technology*, vol. 28, pp.2162-2172, August 2010.
- [7] H. Lee, N.i Hayashi, Y. Mizuno, and K. Nakamura, “Slope-assisted Brillouin optical correlation-domain reflectometry using polymer optical fibers with high propagation loss”, *Journal of Lightwave Technology*, vol. 35, pp. 2306-2310, June 2017.
- [8] Q. Li, J. Gan, Y. Wu, Z. Zhang, J. Li, and Z. Yang, “High spatial resolution BOTDR based on differential Brillouin spectrum technique”, *IEEE Photonics Technology Letters*, vol. 28, pp.1493-1496, July 2016.
- [9] Y.Yu, L. Luo, B. Li, K. Soga, and J.Yan, “Frequency resolution quantification of Brillouin-distributed optical fiber sensors”, *IEEE Photonics Technology Letters*, vol. 28, pp. 2367-2369, November 2016.
- [10] F. Ravet, X. Bao, Q.Yu, and L.Chen, “Criterion for subpulse-length resolution and minimum frequency shift in distributed Brillouin sensors”, *IEEE Potonics Technology Letters*, vol. 17, pp.1504-1506, July 2005.